



Installation: hazardous areas - Zone 1 / 2 (Gases) - Zone 21 / 22 (Dusts)
Classification: Group II - Category 2G 2D



REFERENCE STANDARDS

Directive 2014/34/EU

EXECUTION	<ul style="list-style-type: none"> ⊗ II 2 G Ex d IIC Gb ⊗ II 2 D Ex tb IIIC Db
RULES OF COMPLIANCE	EN/IEC 60079-0; EN/IEC 60079-1; EN/IEC 60079-31
EC Type-Examination Certificate	INERIS 12 ATEX9012U
PROTECTION DEGREE	IP66/67
AMBIENT TEMPERATURE	-50°C ÷ +130°C
OTHER AVAILABLE CERTIFICATES	IECEx: IECEx INE 12.0043U INMETRO: CEPEL 13.2241 EAC: TC RU C-IT.BH02.B.00587 (-60°C ÷ +130°C) RUSSIAN MARINE CERTIFICATE (RMRS): 19.02521.280

Mechanical characteristics

Internal flexible pipe	stainless steel
External braid	stainless steel
Terminals	threaded terminals in stainless steel or cold galvanized steel

Applications

FLEXIBLE CONDUITS ARE INSTALLED WHERE CONNECTIONS MUST BE MADE TO EQUIPMENT SUBJECT TO VIBRATIONS: MOTORS, PUMPS, ETC. ALSO FAVOURED FOR CONNECTION TO PEDANT LIGHTING FITTING AND AT BENDS WHERE RIGID CONDUITS IS DIFFICULT TO HANDLE.



On Request Accessories:

- Different lengths from standard
- PVC coating
- Female thread end terminal
- Male or female thread revolving end terminal

Technical Features

TERMINAL ENDS	SIZE	THREAD NPT	INTERNAL DIA. [ØA] [mm]	EXTERNAL DIA. [ØB] [mm]	C - LENGHT [mm]	TERMINAL'S MATERIAL
H*	1N	(1/2")	12	21,5	300	XC or XB (stainless steel) - GB (galvanized steel)
H*	2N	(3/4)	16	29	300	XC or XB (stainless steel) - GB (galvanized steel)
H*	3N	(1")	25	37,5	400	XC or XB (stainless steel) - GB (galvanized steel)
H*	4N	(1-1/4")	32	46,8	400	XC or XB (stainless steel) - GB (galvanized steel)
H*	5N	(1-1/2")	38	53	400	XC or XB (stainless steel) - GB (galvanized steel)
H*	6N	(2")	50	68	400	XC or XB (stainless steel) - GB (galvanized steel)
H*	7N	(2-1/2")	63	85	400	XC or XB (stainless steel) - GB (galvanized steel)
H*	8N	(3")	75	99	400	XC or XB (stainless steel) - GB (galvanized steel)
H*	10N	(4")	100	122	400	XC or XB (stainless steel) - GB (galvanized steel)

	TERMINAL ENDS	SIZE	C - LENGHT [mm]	TERMINAL'S MATERIAL
TFII#	H	2N	0500	XC or XB
TFII#	N	6N	1000	GB

EXAMPLE 1: TFII#H2N00500XC = Flexible Conduit 3/4" Dia. 500mm total lenght c/w stainless steel NPT thread fix male/fix male, Ex C execution

EXAMPLE 2: TFII#N6N01000GB = Flexible Conduit 2" Dia. 1000mm total lenght c/w galvanized steel / fix male / revolving male, Ex B execution

End 1 \ End 2	Execution IIC		Execution IIB		Execution IIC		
	Fixed male NF	Fixed female CF	Revolving male BM	Revolving female BF	Revolving male RM	Revolving female RF	
Execution IIC	Fixed male NF	TFII (H)	TFII (G)	TFII (N)	TFII (I)	TFII (RN)	TFII (RI)
	Fixed female CF		TFII (Z)	TFII (Y)	TFII (D)	TFII (RY)	TFII (RD)
Execution IIB	Revolving male BM		TFII (P)	TFII (E)			
	Revolving female BF			TFII (T)			
Execution IIC	Revolving male RM				TFII (RP)	TFII (RE)	
	Revolving female RF					TFII (RT)	

Reference Details

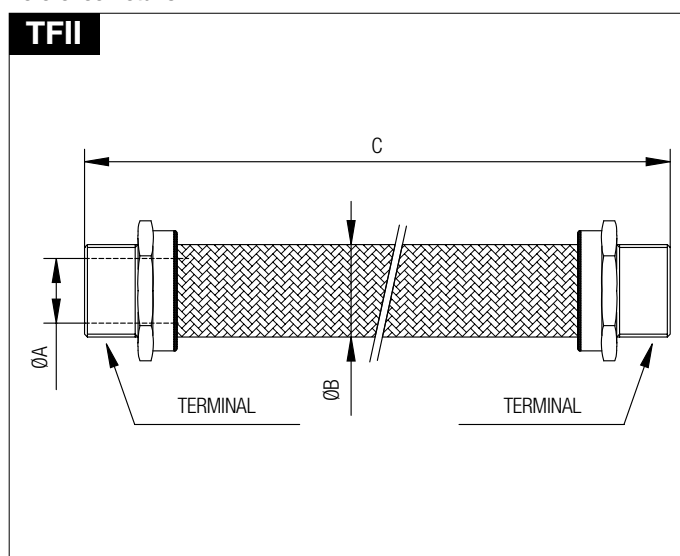

Standard lengths

STANDARD LENGHTS [mm]	FLEXIBLE CONDUIT SIZE							
	01	02	03	04	05	06	07	08
300	X	X	-	-	-	-	-	-
400	X	X	X	X	X	X	X	X
450	X	X	X	X	X	X	X	X
500	X	X	X	X	X	X	X	X
600	X	X	X	X	X	X	X	X
700	X	X	X	X	X	X	X	X
800	X	X	X	X	X	X	X	X
900	X	X	X	X	X	X	X	X
1000	X	X	X	X	X	X	X	X

*FLEX. CONDUIT PIPES WITH LENGHS DIFFERENT THAN STANDARD, PLEASE CONTACT OUR SALES DEPT.

REMARK:

Due to the development of the national and international specifications and of the technology, the above technical characteristics showed on this bulletin can be considered as binding on our confirmation only.