

Non-metallic conduit systems

Introduction to Adaptalok ATS™

Adaptalok ATS™ represents a unique and innovative solution in flexible conduit systems. Until now, manufacturers have produced fittings and seals separately, and assembled them together, or had the customer assemble them. This increases assembly time and introduces the possibility for errors.

—
01 Caption
—
02 Caption

Adaptalok ATS™ uses a sophisticated moulding process to mould an internal conduit seal and a face seal washer. This makes installation times very fast, and extremely reliable, because the seals cannot be left out. The conduit system also benefits from the highest IP rating possible.

Additional key features:

- Nylon 66 body
- Lighter in weight
- Quicker to install (cut & assemble fittings)
- Wider variety of fittings - much larger solutions choice
- Better fatigue life
- Return to shape



Non-metallic conduit systems

Type A - Adaptalok ATSTM™

Type A - Adaptalok ATSTM™

Straight Fitting - Fixed external male thread / Materials: Polyamide (nylon) 66/TPE /
Colour: Black (BL), Grey (GR) / Yellow (Y) Elastomer

Part no.	Nominal conduit size		Part no.	Nominal conduit size		Part no.	Nominal conduit size	
	(mm)	Metric thread		(mm)	PF thread (in)		(mm)	NPT thread (in)
AT13/M16/A	13	M16	AT13/PF038/A	13	3/8	AT13/038/A	13	3/8
AT16/M16/A	16	M16	AT16/PF038/A	16	3/8	AT16/038/A	16	3/8
AT16/M20/A	16	M20	AT16/PF050/A	16	1/2	AT16/050/A	16	1/2
AT21/M20/A	21	M20	AT21/PF050/A	21	1/2	AT21/050/A	21	1/2
AT21/M25/A	21	M25	-	-	-	-	-	-
AT28/M25/A	28	M25	AT28/PF075/A	28	3/4	AT28/075/A	28	3/4
AT28/M32/A	28	M32	-	-	-	-	-	-
AT34/M32/A	34	M32	AT34/PF100/A	34	1	AT34/100/A	34	1
AT34/M40/A	34	M40	-	-	-	-	-	-
AT42/M40/A	42	M40	AT42/PF125/A	42	1 1/4	AT42/125/A	42	1 1/4
AT42/M50/A	42	M50	-	-	-	-	-	-
AT48/M50/A	48	M50	AT48/PF150/A	48	1 1/2	AT48/150/A	48	1 1/2
AT54/M50/A	54	M50	-	-	-	-	-	-
AT54/M63/A	54	M63	AT54/PF200/A	48	2	AT54/200/A	54	2

For insertion into knockouts using a locknut. Locknut supplied with METRIC thread
To order quote part number, body colour & Elastomer colour, e.g. AT21/M20/A/BLY

Approvals



IP rating

Appropriate conduit

For use with: Type PA / PI / PR / PADL / PF

IP40	Yes
IP65	Yes
IP68	Yes (4 bar 30mins)
IP69	Yes

Temperature range

Static applications: -50°C to +120°C
Moving applications: -45°C to +120°C



Non-metallic conduit systems

Type A - Adaptalok ATS™

Type A - Adaptalok ATS™

Straight fitting - Fixed external male thread / Polyamide (nylon) 66/TPE /
Colour: Black (BL), Grey (GR) / Blue (B) Elastomer



Part no.	Nominal conduit size (mm)	Metric thread	Part no.	Nominal conduit size (mm)	NPT thread (in)
AT13/M16/A	13	M16	AT13/038/A	13	3/8
AT16/M16/A	16	M16	AT16/038/A	16	3/8
AT16/M20/A	16	M20	AT16/050/A	16	1/2
AT21/M20/A	21	M20	AT21/050/A	21	1/2
AT21/M25/A	21	M25	-	-	-
AT28/M25/A	28	M25	AT28/075/A	28	3/4
AT28/M32/A	28	M32	-	-	-
AT34/M32/A	34	M32	AT34/100/A	34	1
AT34/M40/A	34	M40	-	-	-
AT42/M40/A	42	M40	AT42/125/A	42	1 1/4
AT42/M50/A	42	M50	-	-	-
AT48/M50/A	48	M50	AT48/150/A	48	1 1/2
AT54/M50/A	54	M50	-	-	-
AT54/M63/A	54	M63	AT54/200/A	54	2

For insertion into knockouts using a locknut. Locknut supplied with METRIC thread
To order quote part number, body colour & Elastomer colour, e.g. AT21/M20/A/BLB

Approvals



IP rating

Appropriate conduit

For use with: Type PA / PI / PR / PADL / PF

IP40	Yes
IP65	Yes
IP68	Yes (4 bar 30mins)
IP69	Yes

Temperature range

Static applications: -50°C to +120°C

Moving applications: -45°C to +120°C

Non-metallic conduit systems

Type C90 - Adaptalok ATS™

Type C90 - Adaptalok ATS™

90° Elbow fitting - Fixed external male thread / Materials: Polyamide (nylon) 66/TPE /
Colour: Black (BL), Grey (GR) / Yellow (Y) Elastomer

Part no.	Nominal conduit size (mm)		Metric thread	Part no.	Nominal conduit size (mm)		PF thread (in)	Part no.	Nominal conduit size (mm)		NPT thread (in)
	AT13/M16/C90	13	M16	AT13/PF038/C90	13	3/8		AT13/038/C90	13	3/8	
	AT16/M16/C90	16	M16	AT16/PF038/C90	16	3/8		AT16/038/C90	16	3/8	
	AT16/M20/C90	16	M20	AT16/PF050/C90	16	1/2		AT16/050/C90	16	1/2	
	AT21/M20/C90	21	M20	AT21/PF050/C90	21	1/2		AT21/050/C90	21	1/2	
	AT21/M25/C90	28	M25	AT28/PF075/C90	28	3/4		AT28/075/C90	28	3/4	
	AT28/M32/C90	34	M32	AT34/PF100/C90	34	1		AT34/100/C90	34	1	
	AT28/M40/C90	42	M40	AT42/PF125/C90	42	1 1/4		AT42/125/C90	42	1 1/4	
	AT34/M50/C90	48	M50	AT48/PF150/C90	48	1 1/2		AT48/150/C90	48	1 1/2	
	AT34/M50/C90	54	M50	AT54/PF150/C90	54	1 1/2		AT54/150/C90	54	1 1/2	
	AT42/M63/C90	54	M63	AT54/PF200/C90	54	2		AT54/200/C90	54	2	



For insertion into knockouts using a locknut. Locknut supplied with METRIC thread
To order quote part number, body colour & Elastomer colour, e.g. AT21/M20/C90/BL/Y

Approvals



IP rating

Appropriate conduit

IP rating	Appropriate conduit
For use with: Type PA / PI / PR / PADL / PF	
IP40	Yes
IP65	Yes
IP68	Yes (4 bar 30mins)
IP69	Yes

Temperature range

Static applications: -50°C to +120°C
Moving applications: -45°C to +120°C

Type C90 - Adaptalok ATS™

90° Elbow fitting - Fixed external male thread / Materials: Polyamide (nylon) 66/TPE /
Colour: Black (BL), Grey (GR) / Blue (B) Elastomer

Part no.	Nominal conduit size (mm)		Metric thread	Part no.	Nominal conduit size (mm)		PF thread (in)
	AT13/M16/C90	13	M16	AT13/PF038/C90	13	3/8	
	AT16/M16/C90	16	M16	AT16/PF038/C90	16	3/8	
	AT16/M20/C90	16	M20	AT16/PF050/C90	16	1/2	
	AT21/M20/C90	21	M20	AT21/PF050/C90	21	1/2	
	AT21/M25/C90	28	M25	AT28/PF075/C90	28	3/4	
	AT28/M32/C90	34	M32	AT34/PF100/C90	34	1	
	AT28/M40/C90	42	M40	AT42/PF125/C90	42	1 1/4	
	AT34/M50/C90	48	M50	AT48/PF150/C90	48	1 1/2	
	AT34/M50/C90	54	M50	AT54/PF150/C90	54	1 1/2	
	AT42/M63/C90	54	M63	AT54/PF200/C90	54	2	



For insertion into knockouts using a locknut. Locknut supplied with METRIC thread
To order quote part number, body colour & Elastomer colour, e.g. AT21/M20/A/BLB

Approvals



IP rating

Appropriate conduit

IP rating	Appropriate conduit
For use with: Type PA / PI / PR / PADL / PF	
IP40	Yes
IP65	Yes
IP68	Yes (4 bar 30mins)
IP69	Yes

Temperature range

Static applications: -50°C to +120°C
Moving applications: -45°C to +120°C

Non-metallic conduit systems

Type 45 - Adaptalok ATS™

Type 45 - Adaptalok ATS™

45° Elbow fitting - Fixed external male thread / Materials: Polyamide (nylon) 66/TPE / Colour: Black (BL), Grey (GR) / Yellow (Y) Elastomer

Part no.	Nominal conduit size (mm)		Metric thread	Part no.	Nominal conduit size (mm)		PF thread (in)	Part no.	Nominal conduit size (mm)		NPT thread (in)
	AT13/M16/45	13	M16	AT13/PF038/45	13	3/8		AT13/038/45	13	3/8	
	AT16/M16/45	16	M16	AT16/PF038/45	16	3/8		AT16/038/45	16	3/8	
	AT16/M20/45	16	M20	AT16/PF050/45	16	1/2		AT16/050/45	16	1/2	
	AT21/M20/45	21	M20	AT21/PF050/45	21	1/2		AT21/050/45	21	1/2	
	AT21/M25/45	28	M25	AT28/PF075/45	28	3/4		AT28/075/45	28	3/4	
	AT28/M32/45	34	M32	AT34/PF100/45	34	1		AT34/100/45	34	1	
	AT28/M40/45	42	M40	AT42/PF125/45	42	1 1/4		AT42/125/45	42	1 1/4	
	AT34/M50/45	48	M50	AT48/PF150/45	48	1 1/2		AT48/150/45	48	1 1/2	
	AT34/M50/45	54	M50	-	-	-		-	-	-	

For insertion into knockouts using a locknut. Locknut supplied with METRIC thread
To order quote part number, body colour & Elastomer colour, e.g. AT54/M50/45/BLY

Approvals



IP rating

Appropriate conduit

IP rating	Appropriate conduit
For use with: Type PA / PI / PR / PADL / PF	
IP40	Yes
IP65	Yes
IP68	Yes (4 bar 30mins)
IP69	Yes

Temperature range

Static applications: -50°C to +120°C
Moving applications: -45°C to +120°C

Type 45 - Adaptalok ATS™

45° Elbow fitting - Fixed external male thread / Materials: Polyamide (nylon) 66/TPE / Colour: Black (BL), Grey (GR) / Blue (BQ) Elastomer

Part no.	Nominal conduit size (mm)		Metric thread	Part no.	Nominal conduit size (mm)		PF thread (in)
	AT13/M16/45	13	M16	AT13/PF038/45	13	3/8	
	AT16/M16/45	16	M16	AT16/PF038/45	16	3/8	
	AT16/M20/45	16	M20	AT16/PF050/45	16	1/2	
	AT21/M20/45	21	M20	AT21/PF050/45	21	1/2	
	AT21/M25/45	28	M25	AT28/PF075/45	28	3/4	
	AT28/M32/45	34	M32	AT34/PF100/45	34	1	
	AT28/M40/45	42	M40	AT42/PF125/45	42	1 1/4	
	AT34/M50/45	48	M50	AT48/PF150/45	48	1 1/2	
	AT34/M50/45	54	M50	-	-	-	

For insertion into knockouts using a locknut. Locknut supplied with METRIC thread
To order quote part number, body colour & Elastomer colour, e.g. AT54/M50/45/BLB

Approvals



IP rating

Appropriate conduit

IP rating	Appropriate conduit
For use with: Type PA / PI / PR / PADL / PF	
IP40	Yes
IP65	Yes
IP68	Yes (4 bar 30mins)
IP69	Yes

Temperature range

Static applications: -50°C to +120°C
Moving applications: -45°C to +120°C

Non-metallic conduit systems



Type SA & CS90 - Adaptalok ATS™

Type SA - Adaptalok ATS™

Straight fitting - Metal swivel external male thread / Materials: Polyamide (nylon) 66, Nickel plated brass thread/TPE / Colour: Black (BL), Grey (GR) / Yellow (Y), Blue (B) Elastomer

	Nominal conduit size		Metric thread	Nominal conduit size		NPT thread (in)
	Part no.	(mm)		Part no.	(mm)	
	AT13/M16/SA	13	M16	AT13/038/SA	13	3/8
	AT16/M16/SA	16	M16	AT16/038/SA	16	3/8
	AT21/M20/SA	21	M20	AT21/050/SA	21	1/2
	AT28/M25/SA	28	M25	AT28/075/SA	28	3/4
	AT34/M32/SA	34	M32	AT34/100/SA	34	1
	AT42/M40/SA	42	M40	AT42/125/SA	42	1 1/4
	AT48/M50/SA	48	M50	AT48/150/SA	48	1 1/2
	AT54/M50/SA	54	M50	AT54/150/SA	54	1 1/2
	AT54/M63/SA	54	M63	AT54/200/SA	54	2

For insertion into threaded entries & knockouts. Order locknuts separately
To order quote part number, body colour & Elastomer colour, e.g. AT16/M16/SA/BLB



Approvals	Blue Elastomer version only	IP rating	Appropriate conduit	Temperature range		
		For use with: Type PA / PI / PR / PADL / PF		Static applications: -50°C to +120°C		
		IP40	Yes	Moving applications: -45°C to +120°C		
		IP65	Yes	Fitting characteristics		
		IP68	Yes (4 bar 30mins)			
		IP69	Yes			

Type CS90 - Adaptalok ATS™

90° Elbow fitting - Swivel external male thread / Materials: Polyamide (nylon) 66, nickel plated brass thread/TPE Colour: Black (BL), Grey (GR) / Yellow (Y), Blue (B) Elastomer

	Nominal conduit size		Metric thread	Nominal conduit size		NPT thread (in)
	Part no.	(mm)		Part no.	(mm)	
	AT13/M16/CS90	13	M16	AT13/038/CS90	13	3/8
	AT16/M16/CS90	16	M16	AT16/038/CS90	16	3/8
	AT21/M20/CS90	21	M20	AT21/050/CS90	21	1/2
	AT28/M25/CS90	28	M25	AT28/075/CS90	28	3/4
	AT34/M32/CS90	34	M32	AT34/100/CS90	34	1
	AT42/M40/CS90	42	M40	AT42/125/CS90	42	1 1/4
	AT48/M50/CS90	48	M50	AT48/150/CS90	48	1 1/2
	AT54/M50/CS90	54	M50	AT54/150/CS90	54	1 1/2
	AT54/M63/CS90	54	M63	AT54/200/CS90	54	2

For insertion into threaded entries & knockouts. Order locknuts separately
To order quote part number, body colour & Elastomer colour, e.g. AT16/M16/SA/BLB

Approvals	Blue Elastomer version only	IP rating	Appropriate conduit	Temperature range		
		For use with: Type PA / PI / PR / PADL / PF		Static applications: -50°C to +120°C		
		IP40	Yes	Moving applications: -45°C to +120°C		
		IP65	Yes	Fitting characteristics		
		IP68	Yes (4 bar 30mins)			
		IP69	Yes			

Non-metallic conduit systems



Type S45 & SFA - Adaptalok ATS™

Type S45 - Adaptalok ATS™

45° Elbow body - Swivel external male thread / Materials: Polyamide (nylon) 66, nickel plated brass thread/TPE
Colour: Black (BL), Grey (GR) / Yellow (Y), Blue (B) Elastomer

	Nominal conduit size		Metric thread	Nominal conduit size		NPT thread (in)
	Part no.	(mm)		Part no.	(mm)	
	AT13/M16/S45	13	M16	AT13/038/S45	13	3/8
	AT16/M16/S45	16	M16	AT16/038/S45	16	3/8
	AT21/M20/S45	21	M20	AT21/050/S45	21	1/2
	AT28/M25/S45	28	M25	AT28/075/S45	28	3/4
	AT34/M32/S45	34	M32	AT34/100/S45	34	1
	AT42/M40/S45	42	M40	AT42/125/S45	42	1 1/4
	AT48/M50/S45	48	M50	AT48/150/S45	48	1 1/2
	AT54/M50/S45	54	M50	AT54/150/S45	54	1 1/2
	AT54/M63/S45	54	M63	AT54/200/S45	54	2

For insertion into threaded entries & knockouts. Order locknuts separately
To order quote part number, body colour & Elastomer colour, e.g. AT54/M63/S45/BLB



Approvals	Blue Elastomer version only	IP rating	Appropriate conduit	Temperature range	
		For use with: Type PA / PI / PR / PADL / PF		Static applications: -50°C to +120°C	
		IP40	Yes	Moving applications: -45°C to +120°C	
		IP65	Yes	Fitting characteristics	
		IP68	Yes (4 bar 30mins)		
		IP69	Yes		

Type SFA - Adaptalok ATS™

Straight fitting - Swivel internal female thread / Materials: Polyamide (nylon) 66, nickel plated brass thread/TPE
Colour: Black (BL), Grey (GR) / Yellow (Y), Blue (B) Elastomer

	Nominal conduit size		Metric thread	Nominal conduit size		NPT thread (in)
	Part no.	(mm)		Part no.	(mm)	
	AT13/M16/SFA	13	M16	AT13/038/SFA	13	3/8
	AT16/M16/SFA	16	M16	AT16/038/SFA	16	3/8
	AT21/M20/SFA	21	M20	AT21/050/SFA	21	1/2
	AT28/M25/SFA	28	M25	AT28/075/SFA	28	3/4
	AT34/M32/SFA	34	M32	AT34/100/SFA	34	1
	AT42/M40/SFA	42	M40	AT42/125/SFA	42	1 1/4
	AT48/M50/SFA	48	M50	AT48/150/SFA	48	1 1/2
	AT54/M50/SFA	54	M50	-	-	-
	AT54/M63/SFA	54	M63	AT54/200/SFA	54	2

For attachments to external threads & other fittings
To order quote part number, body colour & Elastomer colour, e.g. AT54/M63/SFA/BLB

Approvals	Blue Elastomer version only	IP rating	Appropriate conduit	Temperature range	
		For use with: Type PA / PI / PR / PADL / PF		Static applications: -50°C to +120°C	
		IP40	Yes	Moving applications: -45°C to +120°C	
		IP65	Yes	Fitting characteristics	
		IP68	Yes (4 bar 30mins)		
		IP69	Yes		

Non-metallic conduit systems



Type CSF90 & SF45 - Adaptalok ATSTM™

Type CSF90 - Adaptalok ATSTM™

90° Elbow body - Swivel internal female thread / Materials: Polyamide (nylon) 66, nickel plated brass thread/TPE / Colour: Black (BL), Grey (GR) / Yellow (Y), Blue (B) Elastomer

	Nominal conduit size			Nominal conduit size		
	Part no.	(mm)	Metric thread	Part no.	(mm)	NPT thread (in)
	AT13/M16/CSF90	13	M16	AT13/038/CSF90	13	3/8
	AT16/M16/CSF90	16	M16	AT16/038/CSF90	16	3/8
	AT21/M20/CSF90	21	M20	AT21/050/CSF90	21	1/2
	AT28/M25/CSF90	28	M25	AT28/075/CSF90	28	3/4
	AT34/M32/CSF90	34	M32	AT34/100/CSF90	34	1
	AT42/M40/CSF90	42	M40	AT42/125/CSF90	42	1 1/4
	AT48/M50/CSF90	48	M50	AT48/150/CSF90	48	1 1/2
	AT54/M50/CSF90	54	M50	-	-	-
	AT54/M63/CSF90	54	M63	AT54/200/CSF90	54	2

For insertion into threaded entries & knockouts. Order locknuts separately
To order quote part number, body colour & Elastomer colour, e.g. AT16/M16/CSF90/BLB



Approvals	Blue Elastomer version only	IP rating	Appropriate conduit	Temperature range
 NF Ui		For use with: Type PA / PI / PR / PADL / PF		Static applications: -50°C to +120°C
		IP40	Yes	Moving applications: -45°C to +120°C
		IP65	Yes	Fitting characteristics 
	IP68	Yes (4 bar 30mins)		
	IP69	Yes		

Type SF45 - Adaptalok ATSTM™

45° Elbow body - Swivel internal female thread / Materials: Polyamide (nylon) 66, nickel plated brass thread/TPE Colour: Black (BL), Grey (GR) / Yellow (Y), Blue (B) Elastomer

	Nominal conduit size			Nominal conduit size		
	Part no.	(mm)	Metric thread	Part no.	(mm)	NPT thread (in)
	AT13/M16/SF45	13	M16	AT13/038/SF45	13	3/8
	AT16/M16/SF45	16	M16	AT16/038/SF45	16	3/8
	AT21/M20/SF45	21	M20	AT21/050/SF45	21	1/2
	AT28/M25/SF45	28	M25	AT28/075/SF45	28	3/4
	AT34/M32/SF45	34	M32	AT34/100/SF45	34	1
	AT42/M40/SF45	42	M40	AT42/125/SF45	42	1 1/4
	AT48/M50/SF45	48	M50	AT48/150/SF45	48	1 1/2
	AT54/M50/SF45	54	M50	-	-	-
	AT54/M63/SF45	54	M63	AT54/200/SF45	54	2

For attaching to external threads & other fittings
To order quote part number, body colour & Elastomer colour, e.g. AT16/M16/SF45/BLB

Approvals	Blue Elastomer version only	IP rating	Appropriate conduit	Temperature range
 NF Ui		For use with: Type PA / PI / PR / PADL / PF		Static applications: -50°C to +120°C
		IP40	Yes	Moving applications: -45°C to +120°C
		IP65	Yes	Fitting characteristics 
	IP68	Yes (4 bar 30mins)		
	IP69	Yes		

Non-metallic conduit systems

Swivel Housing Type SFAJ, CSF90J & SF45J - Adaptalok ATST™

Type SFAJ - Adaptalok ATST™

Straight fitting - Swivel housing / Materials: Polyamide (nylon) 66, nickel plated brass thread/TPE
Colour: Black (BL), Grey (GR) / Yellow (Y) Elastomer



Part no.	Nominal conduit size (mm)	Metric thread
AT16/M16/SFAJ	16	M16
AT21/M20/SFAJ	21	M20
AT28/M25/SFAJ	28	M25
AT34/M32/SFAJ	34	M32
AT42/M40/SFAJ	42	M40
AT54/M50/SFAJ	54	M50
AT54/M63/SFAJ	54	M63

Swivel metal housing for use with Jacob PERFECT cable glands
To order quote part number, body colour & Elastomer colour, e.g. AT54/M63/SFAJ/BLY

Type CSF90J - Adaptalok ATST™

90° Elbow body - Swivel Housing / Materials: Polyamide (nylon) 66, nickel plated brass thread/TPE
Colour: Black (BL), Grey (GR) / Yellow (Y) Elastomer



Part no.	Nominal conduit size (mm)	Metric thread
AT16/M16/CSF90J	16	M16
AT21/M20/CSF90J	21	M20
AT28/M25/CSF90J	28	M25
AT34/M32/CSF90J	34	M32
AT42/M40/CSF90J	42	M40
AT54/M50/CSF90J	54	M50
AT54/M63/CSF90J	54	M63

Swivel metal housing for use with Jacob PERFECT cable glands
To order quote part number, body colour & Elastomer colour, e.g. AT16/M16/CSF90J/BLY

Type SF45 - Adaptalok ATST™

45° Elbow body - Swivel housing / Materials: Polyamide (nylon) 66, nickel plated brass thread/TPE
Colour: Black (BL), Grey (GR) / Yellow (Y) Elastomer



Part no.	Nominal conduit size (mm)	Metric thread
AT16/M16/SF45J	16	M16
AT21/M20/SF45J	21	M20
AT28/M25/SF45J	28	M25
AT34/M32/SF45J	34	M32
AT42/M40/SF45J	42	M40
AT54/M50/SF45J	54	M50
AT54/M63/SF45J	54	M63

Swivel metal housing for use with Jacob PERFECT cable glands
To order quote part number, body colour & Elastomer colour, e.g. AT16/M16/SF45J/BLY

Approvals



IP rating Appropriate conduit

IP rating	Appropriate conduit
For use with: Type PA / PI / CP / PR / PF	
IP40	Yes
IP65	Yes
IP68	Yes (4 bar 30mins)
IP69	N/A

Temperature range

Static applications: -50°C to +120°C
Moving applications: -45°C to +120°C

Fitting characteristics



Non-metallic conduit systems

UNEF Type SFA - Adaptalok ATS™



UNEF Type SFA - Adaptalok ATS™

Straight body - Swivel internal female thread / Materials: Polyamide (nylon) 66, aluminium/TPE / Colour: Black (BL) Only / Yellow (Y), Blue (B) Elastomer

	Part no.	Nominal conduit size (mm)	Connector UNEF thread		Part no.	Nominal conduit size (mm)	Connector UNEF thread
	AT13/U063/SFA	13	5/8" - 24		AT21/U144/SFA	21	1 7/16" - 18
	AT13/U075/SFA	13	3/4" - 20		AT21/U175/SFA	21	1 3/4" - 18
	AT13/U088/SFA	13	7/8" - 20		AT28/U088/SFA	28	7/8" - 20
	AT16/U063/SFA	16	5/8" - 24		AT28/U094/SFA	28	1 5/16" - 20
	AT16/U075/SFA	16	3/4" - 20		AT28/U100/SFA	28	1" - 20
	AT16/U081/SFA	16	1 3/16" - 20		AT28/U119/SFA	28	1 3/16" - 18
	AT16/U088/SFA	16	7/8" - 20		AT28/U138/SFA	28	1 3/8" - 18
	AT16/U094/SFA	16	1 5/16" - 20		AT28/U144/SFA	28	1 7/16" - 18
	AT16/U100/SFA	16	1" - 20		AT28/U175/SFA	28	1 3/4" - 18
	AT16/U119/SFA	16	1 3/16" - 18		AT28/U200/SFA	28	2" - 16
	AT16/U131/SFA	16	1 5/16" - 18		AT28/U225/SFA	28	2 1/4" - 16
	AT21/U075/SFA	21	3/4" - 20		AT34/U100/SFA	34	1" - 20
	AT21/U088/SFA	21	7/8" - 20		AT34/U119/SFA	34	1 3/16" - 18
	AT21/U094/SFA	21	1 5/16" - 20		AT34/U144/SFA	34	1 7/16" - 18
	AT21/U100/SFA	21	1" - 20		AT34/U175/SFA	34	1 3/4" - 18
	AT21/U113/SFA	21	1 1/8" - 18		AT34/U200/SFA	34	2" - 16
	AT21/U119/SFA	21	1 3/16" - 18		AT42/U175/SFA	42	1 3/4" - 18
	AT21/U131/SFA	21	1 5/16" - 18		AT42/U200/SFA	42	2" - 16
	AT21/U138/SFA	21	1 3/8" - 18		-	-	-

For coupling to UNEF circular connectors

To order quote part number, body colour & Elastomer colour, e.g. AT16/U063/SFA/BLB

Approvals	Blue Elastomer version only	IP rating	Appropriate conduit	Temperature range
		For use with: Type PA / PI / PR / PADL / PF		Static applications: -50°C to +120°C
		IP40	Yes	Moving applications: -45°C to +120°C
		IP65	Yes	Fitting characteristics
		IP68	Yes (4 bar 30mins)	
IP69	Yes			

Non-metallic conduit systems

UNEF Type CSF90 - Adaptalok ATSTM





UNEF Type CSF90 - Adaptalok ATSTM

90° Elbow body - Swivel internal female thread / Materials: Polyamide (nylon) 66, nickel plated brass thread/TPE / Colour: Black (BL), Grey (GR) / Yellow (Y) Elastomer

Part no.	Nominal conduit size (mm)	Connector UNEF thread	Part no.	Nominal conduit size (mm)	Connector UNEF thread
AT13/U063/CSF90	13	5/8" - 24	AT21/U144/CSF90	21	1 7/16" - 18
AT13/U075/CSF90	13	3/4" - 20	AT21/U175/CSF90	21	1 3/4" - 18
AT13/U088/CSF90	13	7/8" - 20	AT28/U088/CSF90	28	7/8" - 20
AT16/U063/CSF90	16	5/8" - 24	AT28/U094/CSF90	28	1 5/16" - 20
AT16/U075/CSF90	16	3/4" - 20	AT28/U100/CSF90	28	1" - 20
AT16/U081/CSF90	16	1 3/16" - 20	AT28/U119/CSF90	28	1 3/16" - 18
AT16/U088/CSF90	16	7/8" - 20	AT28/U138/CSF90	28	1 3/8" - 18
AT16/U094/CSF90	16	1 5/16" - 20	AT28/U144/CSF90	28	1 7/16" - 18
AT16/U100/CSF90	16	1" - 20	AT28/U175/CSF90	28	1 3/4" - 18
AT16/U119/CSF90	16	1 3/16" - 18	AT28/U200/CSF90	28	2" - 16
AT16/U131/CSF90	16	1 5/16" - 18	AT28/U225/CSF90	28	2 1/4" - 16
AT21/U075/CSF90	21	3/4" - 20	AT34/U100/CSF90	34	1" - 20
AT21/U088/CSF90	21	7/8" - 20	AT34/U119/CSF90	34	1 3/16" - 18
AT21/U094/CSF90	21	1 5/16" - 20	AT34/U144/CSF90	34	1 7/16" - 18
AT21/U100/CSF90	21	1" - 20	AT34/U175/CSF90	34	1 3/4" - 18
AT21/U113/CSF90	21	1 1/8" - 18	AT34/U200/CSF90	34	2" - 16
AT21/U119/CSF90	21	1 3/16" - 18	AT42/U175/CSF90	42	1 3/4" - 18
AT21/U131/CSF90	21	1 5/16" - 18	AT42/U200/CSF90	42	2" - 16
AT21/U138/CSF90	21	1 3/8" - 18	-	-	-



For coupling to UNEF circular connectors
To order quote part number, body colour & Elastomer colour, e.g. AT16/U063/CSF90/BLB

Approvals	Blue Elastomer version only	IP rating	Appropriate conduit	Temperature range	Fitting characteristics
   NF UI		For use with: Type PA / PI / PR / PADL / PF IP40 IP65 IP68 IP69	Yes Yes Yes (4 bar 30mins) Yes	Static applications: -50°C to +120°C Moving applications: -45°C to +120°C	

Non-metallic conduit systems

UNEF Type SF45 - Adaptalok ATSTM™





UNEF Type SF45 - Adaptalok ATSTM™

45° Elbow body - Swivel internal female thread / Materials: Polyamide (nylon) 66, aluminium/TPE / Colour: Black (BL) Only / Yellow (Y), Blue (B) Elastomer

	Part no.	Nominal conduit size		Part no.	Nominal conduit size	
		(mm)	Metric thread		(mm)	NPT thread
	AT13/U063/SF45	13	5/8" - 24	AT21/U144/SF45	21	1 7/16" - 18
	AT13/U075/SF45	13	3/4" - 20	AT21/U175/SF45	21	1 3/4" - 18
	AT13/U088/SF45	13	7/8" - 20	AT28/U088/SF45	28	7/8" - 20
	AT16/U063/SF45	16	5/8" - 24	AT28/U094/SF45	28	1 5/16" - 20
	AT16/U075/SF45	16	3/4" - 20	AT28/U100/SF45	28	1" - 20
	AT16/U081/SF45	16	1 3/16" - 20	AT28/U119/SF45	28	1 3/16" - 18
	AT16/U088/SF45	16	7/8" - 20	AT28/U138/SF45	28	1 3/8" - 18
	AT16/U094/SF45	16	1 5/16" - 20	AT28/U144/SF45	28	1 7/16" - 18
	AT16/U100/SF45	16	1" - 20	AT28/U175/SF45	28	1 3/4" - 18
	AT16/U119/SF45	16	1 1/8" - 18	AT28/U200/SF45	28	2" - 16
	AT16/U131/SF45	16	1 5/16" - 18	AT28/U225/SF45	28	2 1/4" - 16
	AT21/U075/SF45	21	3/4" - 20	AT34/U100/SF45	34	1" - 20
	AT21/U088/SF45	21	7/8" - 20	AT34/U119/SF45	34	1 3/16" - 18
	AT21/U094/SF45	21	1 5/16" - 20	AT34/U144/SF45	34	1 7/16" - 18
	AT21/U100/SF45	21	1" - 20	AT34/U175/SF45	34	1 3/4" - 18
	AT21/U113/SF45	21	1 1/8" - 18	AT34/U200/SF45	34	2" - 16
	AT21/U119/SF45	21	1 3/16" - 18	AT42/U175/SF45	42	1 3/4" - 18
	AT21/U131/SF45	21	1 5/16" - 18	AT42/U200/SF45	42	2" - 16
	AT21/U138/SF45	21	1 3/8" - 18	-	-	-

For coupling to UNEF circular connectors

To order quote part number, body colour & Elastomer colour, e.g. AT16/U063/SF45/BLB



Approvals	Blue Elastomer version only	IP rating	Appropriate conduit	Temperature range	Fitting characteristics
   NF UI		For use with: Type PA / PI / PR / PADL / PF		Static applications: -50°C to +120°C	
		IP40	Yes	Moving applications: -45°C to +120°C	
		IP65	Yes		
		IP68	Yes (4 bar 30mins)		
		IP69	Yes		

Non-metallic conduit systems



Swivel Coupler & Panel Mounting Type FL/A - Adaptalok ATST™

Swivel Coupler - Adaptalok ATST™

Straight PA66 body - Swivel coupler / Materials: Polyamide (nylon) 66/TPE / Colour: Black (BL) Only / Yellow (Y), Blue (B) Elastomer

	Part no.	Nominal conduit size (mm)
	AT13/A/U	13
	AT16/A/U	16
	AT21/A/U	21
	AT28/A/U	28
	AT34/A/U	34
	AT42/A/U	42
	AT48/A/U	48
	AT54/A/U	54

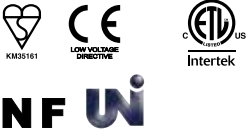
For coupling to corrugated flexible conduit
To order quote part number, body colour & Elastomer colour, e.g. AT21/A/U/BLB



Approvals	Blue Elastomer version only	IP rating	Appropriate conduit	Temperature range	Fitting characteristics
		For use with: Type PA / PI / PR / PADL / PF		Static applications: -50°C to +120°C	
		IP40	Yes	Moving applications: -45°C to +120°C	
		IP65	Yes		
		IP68	Yes (4 bar 30mins)		
		IP69	Yes		

Panel Mounting Type FL/A - Adaptalok ATST™

Straight panel mounting-swivel flange / Materials: Polyamide (nylon) 66/TPE / Colour: Black (BL) Only / Yellow (Y), Blue (B) Elastomer

	Part no.	Nominal conduit size (mm)
	AT16/FL/A	16
	AT21/FL/A	21
	AT28/FL/A	28

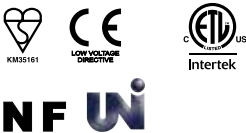
With integral face seal
To order quote part number, body colour & Elastomer colour, e.g. AT21/FL/A/BLB

Approvals	Blue Elastomer version only	IP rating	Appropriate conduit	Temperature range	Fitting characteristics
		For use with: Type PA / PI / PR / PADL / PF		Static applications: -50°C to +120°C	
		IP40	Yes	Moving applications: -45°C to +120°C	
		IP65	Yes		
		IP68	Yes (4 bar 30mins)		
		IP69	Yes		

Non-metallic conduit systems

Panel Mounting Type FL/C90 & FL45 - Adaptalok ATSTM™

Panel Mounting Type FL/C90 - Adaptalok ATSTM™

90° Elbow body - Panel mounting swivel flange / Materials: Polyamide (nylon) 66/TPE / Colour: Black (BL) Only / Yellow (Y), Blue (B) Elastomer

	Part no.	Nominal conduit size (mm)
	AT13/FL/C90	13
	AT16/FL/C90	16
	AT21/FL/C90	21
	AT28/FL/C90	28
For panel mounting via 2 hole fixing & integral face seal To order quote part number, body colour & Elastomer colour, e.g. AT21/FL/C90/BLB		

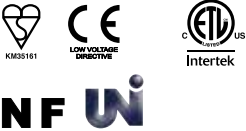
Approvals	Blue Elastomer version only	IP rating	Appropriate conduit	Temperature range		
		For use with: Type PA / PI / PR / PADL / PF		Static applications: -50°C to +120°C		
		IP40	Yes	Moving applications: -45°C to +120°C		
				Fitting characteristics		
		IP65	Yes			
		IP68	Yes (4 bar 30mins)			
		IP69	Yes			

Panel Mounting Type FL45 - Adaptalok ATSTM™

45° Elbow body - Panel mounting swivel flange / Materials: Polyamide (nylon) 66/TPE / Colour: Black (BL), Grey (GR) / Yellow (W), Blue (B) Elastomer

	Part no.	Nominal conduit size (mm)
	AT16/FL/45	16
	AT21/FL/45	21
	AT28/FL/45	28
	With integral face seal To order quote part number, body colour & Elastomer colour, e.g. AT21/FL/45/BLB	

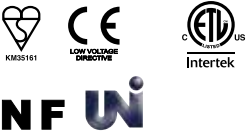
Approvals	Blue Elastomer version only	IP rating	Appropriate conduit	Temperature range		
		For use with: Type PA / PI / PR / PADL / PF		Static applications: -50°C to +120°C		
		IP40	Yes	Moving applications: -45°C to +120°C		
				Fitting characteristics		
		IP65	Yes			
		IP68	Yes (4 bar 30mins)			
		IP69	Yes			

Non-metallic conduit systems

Type T - Adaptalok ATSTM

Type T- Adaptalok ATSTM

3 Way 'T' piece / Materials: Polyamide (nylon) 66 / Colour: Black (BL), Grey (GR) / Yellow (Y) Elastomer

		Nominal dimensions / Conduit size (mm)					
	Part no.	A	B	C	D	E	
	21T	AT211316/T	82	129	21	16	13
		AT211321/T	82	122	21	21	13
		AT211613/T	83	129	21	13	16
		AT211616/T	83	129	21	16	16
		AT211621/T	83	122	21	21	16
		AT212113/T	75	129	21	21	13
		AT211616/T	83	129	21	16	16
		AT212121/T	77	122	21	21	21
	28T	AT212821/T	82	152	21	21	28
		AT281321/T	88	141	28	21	13
		AT281328/T	88	129	28	28	13
		AT281621/T	90	141	28	21	16
		AT281628/T	90	129	28	28	16
		AT282121/T	93	141	28	21	21
		AT282128/T	93	129	28	28	21
		AT282828/T	82	129	28	28	28
	34T	AT341634/T	98	139	34	34	16
		AT342128/T	104	150	34	28	21
		AT342134/T	104	139	34	34	21
		AT343434/T	91	139	34	34	34

To order quote part number, body colour & Elastomer colour, e.g. AT211316/T/BLY

Approvals

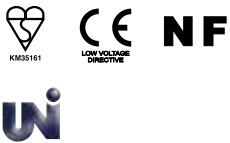

IP rating Appropriate conduit

For use with: Type PA / PI / PR / PADL / PF	
IP66	Yes
IP67	Yes
IP68	Yes (4 bar 30mins)
IP69	Yes

Temperature range

Static applications: -50°C to +120°C
 Moving applications: -45°C to +120°C

Fitting characteristics

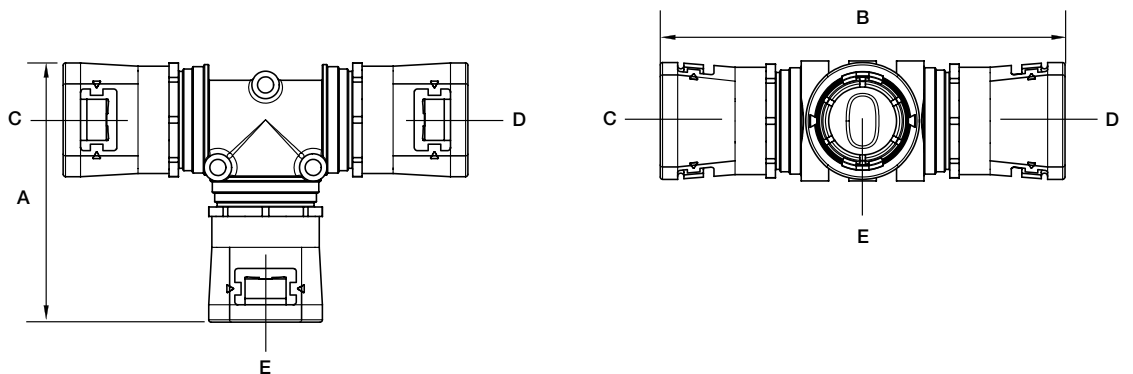

Non-metallic conduit systems

Type T - Adaptalok ATSTM™



Type T- Adaptalok ATSTM™

3 Way 'T' piece / Materials: Polyamide (nylon) 66, / Colour: Black (BL), Grey (GR) / Yellow (Y) Elastomer

		Nominal dimensions/conduit size (mm)					
	Part no.	A	B	C	D	E	
	28Y	AT282113/Y	107.1	117.8	28	21	13
		AT282116/Y	110.6	117.8	28	21	16
		AT282121/Y	116.4	129.9	28	21	21
		AT282813/Y	108.7	124.6	28	28	13
		AT282816/Y	112.2	124.6	28	28	16
		AT282821/Y	116.6	124.6	28	28	21
		AT282828/Y	165.0	119.0	28	28	28

To order quote part number, body colour & Elastomer colour, e.g. AT282113/Y/BLY

Approvals

IP rating	Appropriate conduit
For use with: Type PA / PI / PR / PADL / PF	
IP40	Yes
IP65	Yes
IP68	Yes (4 bar 30mins)
IP69	Yes

Temperature range
Static applications: -50°C to +120°C
Moving applications: -45°C to +120°C
Fitting characteristics

