









Cable Glands for SWA and AWA Cables

ORION



Technical Details			
Material	Body, Cap	Brass, Brass Nickel Plated, Stainless Steel, Aluminium	
	Inner Part	Brass, Brass Nickel Plated, Stainless Steel, Aluminium	
	Seal	CR (Chloroprene) , Silicone	
	O-ring	CR (Chloroprene) , Silicone	
Ingress Protection Rating	IP 68 - 5 Bar, 30 min IP 66		
Operating Temperature	Seal Material		
	CR (Chloroprene)	Silicone	
	Standard	-40°C to +100°C	-60°C to +130°C
LT Type	-40°C to +80°C	-60°C to +80°C	
Equipment For	Gas & Dust potentially explosive atmospheres		
Suitable for use in	Group II	Gas Group IIC	ZONE1/ZONE2
	Group III	Dust Group IIIC	ZONE21/ZONE 22
Equipment Marking	Ex II 2GD Ex db IIC Gb Ex eb IIC Gb Ex tb IIIC Db		
Marking Example *	BMD KBA.. CE 0722  II 2GD Ex db IIC Gb Ex eb IIC Gb Ex tb IIIC Db Ta -60°C to +130°C IP66/68 CESI 13 ATEX 033X IECEx CES 13.0013X		
Thread Type	<ul style="list-style-type: none"> • Metric (M) ISO Pitch 1,5 • NPT (N) ANSI ASME B1.20.1 • Other thread types also available upon request. 		
Cable Type	SWA - AWA		
Accessories	<ul style="list-style-type: none"> • Lock nuts • Gaskets (Washers) • Serrated Washers • Shrouds • Earth tags 		
	<ul style="list-style-type: none"> • O-ring available in Metric outer threads. • Accessories must be ordered separately. 		
	Approvals	Certificate Number	Standards
		CESI 13 ATEX 033X	EN 60079-0:2012+A11:2013 EN 60079-1:2014 EN 60079-7:2015 EN 60079-31:2014
		IECEX CES 13.0013X	IEC 60079-0:2011 Edition:6 IEC 60079-1:2014 Edition:7 IEC 60079-31:2013 Edition:2 IEC 60079-7:2015-08 Edition:5
	20150612-E474828	UL 2225, CAN/CSA-C22.2 No. 60079-0:11 CAN/CSA C22.2 No. 60079-7:12 CAN/CSA-C22.2 No. 60079-31:12	
	20170315-E199260	UL 514B UL50E	
	№ TC RU C-TR.AA87.B.00941	FOCT 31610.0-2014 FOCT IEC 60079-1:2013 FOCT IEC 60079-31:2013	
	DNV 12.0053 X	ABNT NBR IEC 60079-0:2013, ABNT NBR IEC 60079-1:2009, ABNT NBR IEC 60079-7:2008, ABNT NBR IEC 60079-31:2011	
	E-14044	IEC/EN60079-0, IEC/EN60079-7, IEC/EN60079-31 IEC/EN60079-1, IEC/EN 62444	
	MASC MS/18-0240X	SANS (IEC) 60079-0 : 2011 SANS (IEC) 60079-1 : 2014 SANS (IEC) 60079-7 : 2007 SANS (IEC) 60079-31 : 2014	

-For more information see our webpage.

* The standard marking consists ATEX & IECEx only. Marking acc. to other standards on request.

Order Coding							
Part Number	Material	Seal	Gasket (Washer)	Serrated Washer	Lock Nut	Shroud	Earth Tag
Mandatory	Mandatory	Mandatory	- Option	Option	Option	Option	Option
See table	B Brass BN Brass Nickel plated X Stainless steel A Aluminium	C Chloroprene S Silicone	- WC Chloroprene WS Silicone WF Fiber	WSR Serrated washer	L Lock nut	S Shroud	E Earth tag
Example							
KBA1N	BN	S	- WC	-	L	-	E

ORION

Cable Glands for SWA and AWA Cables

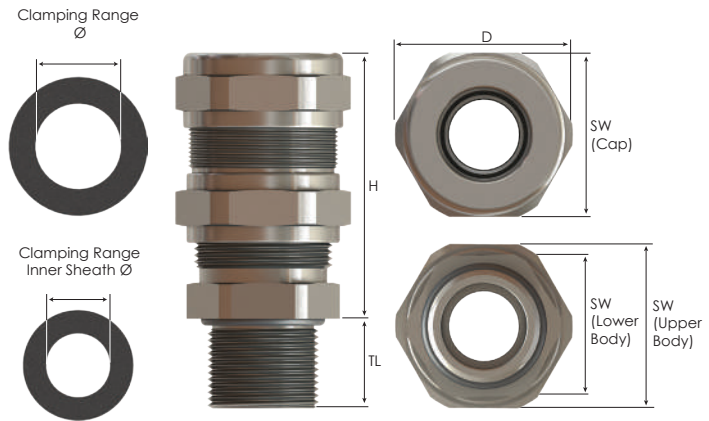

Thread Type **METRIC** acc. to ISO 965-3

Outer Thread Size (Male)	Clamping Range		Armour Wire Ø min-max mm	Outer Thread Length TL mm	Spanner Width		Outer Ø D mm	max. Height H mm	Part Number
	Inner Sheath Ø min-max mm	Ø min-max mm			Upper Body SW Upper Body mm	Lower Body SW Lower Body mm			
M12x1,5	2,0 - 4,0	3,0 - 5,5	0,10 - 0,40	15,0	17	17	18,9	62,5	KBA0SM
	3,0 - 7,5	6,0 - 12,0	0,70 - 1,20	15,0	26	26	29,0	50,5	KBA0SLM
M16x1,5	3,0 - 8,5	6,0 - 12,0	0,70 - 1,20	16,0	26	26	29,0	49,5	KBA01SM
	6,0 - 12,0	8,5 - 16,0	0,70 - 1,25	16,0	29	29	31,5	52,0	KBA01M
M20x1,5	3,0 - 8,5	6,0 - 12,0	0,70 - 1,20	16,0	26	26	29,0	50,0	KBA1SM
	6,0 - 12,0	8,5 - 16,0	0,70 - 1,25	16,0	29	29	31,5	51,5	KBA1M
	8,5 - 14,5	12,0 - 20,0	0,90 - 1,30	16,0	32	30	35,0	54,0	KBA1LM
M25x1,5	3,0 - 8,5	6,0 - 12,0	0,70 - 1,20	18,0	26	26	31,5	50,0	KBA2XSM
	6,0 - 12,0	8,5 - 16,0	0,70 - 1,25	18,0	29	29	31,5	52,5	KBA2SM
	8,5 - 16,0	12,0 - 21,0	0,70 - 1,20	18,0	34	34	37,0	56,5	KBA2M
	12,0 - 20,0	16,0 - 26,0	1,30 - 1,70	18,0	40	40	44,0	63,0	KBA2LM
M32x1,5	6,0 - 12,0	8,5 - 16,0	0,70 - 1,25	18,0	29	29	39,8	52,5	KBA3XSM
	12,0 - 20,0	16,0 - 26,0	1,30 - 1,70	18,0	40	40	44,0	64,0	KBA3SM
	15,0 - 26,0	20,0 - 33,0	1,20 - 1,80	18,0	52	52	57,0	81,0	KBA3M
M40x1,5	12,0 - 20,0	16,0 - 26,0	1,30 - 1,70	18,0	40	40	50,0	64,0	KBA4XSM
	15,0 - 26,0	20,0 - 33,0	1,20 - 1,80	18,0	52	52	57,0	81,0	KBA4SM
	20,0 - 32,0	29,0 - 41,0	1,60 - 2,20	18,0	60	60	66,0	92,0	KBA4M
M50x1,5	15,0 - 26,0	20,0 - 33,0	1,20 - 1,80	18,0	52	52	60,0	81,0	KBA5XSM
	20,0 - 32,0	29,0 - 41,0	1,60 - 2,20	18,0	60	60	66,0	92,0	KBA5XMM
	22,0 - 35,0	33,0 - 48,0	2,00 - 2,80	18,0	75	70	83,0	100,0	KBA5SM
	27,0 - 41,0	36,0 - 52,0	1,80 - 2,80	18,0	74	70	81,8	104,5	KBA5M
M63x1,5	22,0 - 35,0	33,0 - 48,0	2,00 - 2,80	20,0	75	70	83,0	100,0	KBA6XSM
	27,0 - 41,0	36,0 - 52,0	1,80 - 2,80	20,0	74	70	81,8	104,5	KBA6XMM
	35,0 - 45,0	43,0 - 57,0	1,80 - 2,80	20,0	80	80	89,5	109,5	KBA6SM
	40,0 - 52,0	47,0 - 60,0	1,80 - 2,80	20,0	85	85	94,0	111,5	KBA6M
	45,0 - 56,0	54,0 - 70,0	1,30 - 2,50	20,0	100	95	110,5	128,5	KBA6LM
M75x1,5	35,0 - 45,0	43,0 - 57,0	1,80 - 2,80	20,0	80	80	94,0	109,5	KBA7XSM
	40,0 - 52,0	47,0 - 60,0	1,80 - 2,80	20,0	85	85	94,0	111,5	KBA7SM
	45,0 - 60,0	54,0 - 70,0	1,00 - 2,30	20,0	100	95	110,5	127,5	KBA7M
M90x1,5	40,0 - 52,0	47,0 - 60,0	1,80 - 2,80	20,0	85	85	110,5	111,5	KBA8XSM
	45,0 - 60,0	54,0 - 70,0	1,00 - 2,30	20,0	100	95	110,5	127,5	KBA8SM
	60,0 - 72,0	63,0 - 80,0	1,00 - 3,50	20,0	115	115	127,0	158,0	KBA8M
M110x1,5	45,0 - 60,0	54,0 - 70,0	1,00 - 2,30	20,0	100	95	128,0	127,5	KBA10SM
	60,0 - 72,0	63,0 - 80,0	1,00 - 3,50	20,0	115	115	128,0	158,0	KBA10M







Thread Type **METRIC** acc. to ISO 965-3 (LT Type)

Outer Thread Size (Male)	Clamping Range		Armour Wire Ø min-max mm	Outer Thread Length TL mm	Spanner Width		Outer Ø D mm	max. Height H mm	Part Number
	Inner Sheath Ø min-max mm	Ø min-max mm			Upper Body SW Upper Body mm	Lower Body SW Lower Body mm			
M90x2,0	70,0 - 82,0	78,0 - 90,0	1,5 - 4,4	20,0	120	120	134,0	159,5	KBA8MLT
M100x2,0	80,0 - 92,0	88,0 - 100,0	1,2 - 4,0	20,0	135	135	150,0	169,0	KBA9SMLT
M110x2,0	90,0 - 101,0	98,0 - 110,0	2,1 - 5,4	20,0	145	145	162,0	180,0	KBA10MLT
M130x2,0	100,0 - 115,0	109,0 - 123,0	2,0 - 5,4	24,0	160	160	176,0	202,0	KBA13MLT

Cable Glands for Armoured Cables

ORION



Technical Details			
Material	Body, Cap	Brass, Brass Nickel Plated, Stainless Steel, Aluminium	
	Inner Part	Brass, Brass Nickel Plated, Stainless Steel, Aluminium	
	Seal	CR (Chloroprene) , Silicone	
	O-ring	CR (Chloroprene) , Silicone	
Ingress Protection Rating	IP 68 - 5 Bar, 30 min IP 66		
Operating Temperature	Seal Material		
	CR (Chloroprene)	Silicone	
	Standard	-40°C to +100°C	
LT Type	-40°C to +80°C	-60°C to +130°C	
Equipment For	Gas & Dust potentially explosive atmospheres		
Suitable for use in	Group II	Gas Group IIC	ZONE1/ZONE2
Equipment Marking	Group III	Dust Group IIIC	ZONE21/ZONE 22
Marking Example *	Ex II 2GD Ex db IIC Gb Ex eb IIC Gb Ex tb IIIC Db Ta -60°C to +130°C IP66/68 CESI 13 ATEX 033X IECEx CES 13.0013X		
Thread Type	<ul style="list-style-type: none"> • Metric (M) ISO Pitch 1,5 • NPT (N) ANSI ASME B1.20.1 • Other thread types also available upon request. 		
Cable Type	SWA - AWA		
Accessories	<ul style="list-style-type: none"> • Lock nuts • Gaskets (Washers) • Serrated Washers • Shrouds • Earth tags 		
	<ul style="list-style-type: none"> • O-ring available in Metric threads. • Accessories must be ordered separately. 		
Remarks			
Approvals	Certificate Number	Standards	
	CESI 13 ATEX 033X	EN 60079-0:2012+A11:2013 EN 60079-1:2014 EN 60079-7:2015 EN 60079-31:2014	
	IECEx CES 13.0013X	IEC 60079-0:2011 Edition:6 IEC 60079-1:2014 Edition:7 IEC 60079-31:2013 Edition:2 IEC 60079-7:2015-08 Edition:5	
	20150612-E474828	UL 2225, CAN/CSA-C22.2 No. 60079-0:11 CAN/CSA C22.2 No. 60079-7:12 CAN/CSA-C22.2 No. 60079-31:12	
	20170315-E199260	UL 514B UL50E	
	Nº TC RU C-TR.AA87.B.00941	ГОСТ 31610.0-2014 ГОСТ IEC 60079-1:2013 ГОСТ IEC 60079-31:2013	
	DNV 12.0053 X	ABNT NBR IEC 60079-0:2013, ABNT NBR IEC 60079-1:2009, ABNT NBR IEC 60079-7:2008, ABNT NBR IEC 60079-31:2011	
	E-14044	IEC/EN60079-0, IEC/EN60079-7, IEC/EN60079-31 IEC/EN60079-1, IEC/EN 62444	
	MASC MS/18-0240X	SANS (IEC) 60079-0 : 2011 SANS (IEC) 60079-1 : 2014 SANS (IEC) 60079-7 : 2007 SANS (IEC) 60079-31 : 2014	

-For more information see our webpage.

* The standard marking consists ATEX & IECEx only. Marking acc. to other standards on request.

Order Coding							
Part Number	Material	Seal	- Gasket (Washer)	Serrated Washer	Lock Nut	Shroud	Earth Tag
Mandatory	Mandatory	Mandatory	- Option	Option	Option	Option	Option
See table	B Brass BN Brass Nickel plated X Stainless steel A Aluminium	C Chloroprene S Silicone	- WC Chloroprene WS Silicone WF Fiber	WSR Serrated washer	L Lock nut	S Shroud	E Earth tag
Example							
KBA1N	BN	S	- WC	-	L	-	E

ORION Cable Glands for SWA and AWA Cables

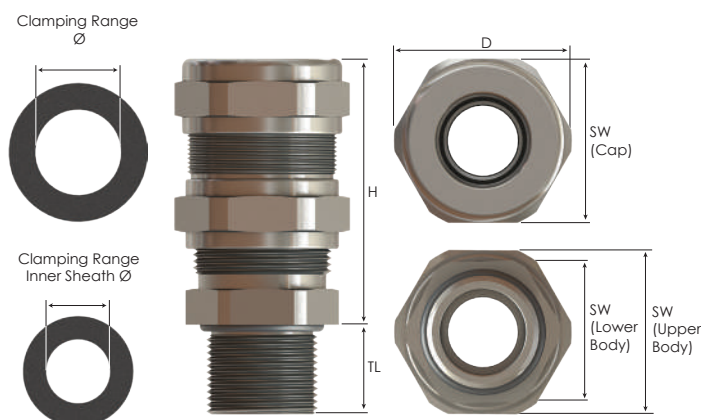

Thread Type **NPT** acc. to ANSI ASME B1.20.1

Outer Thread Size (Male)	Clamping Range		Armour Wire Ø min-max mm	Outer Thread Length TL mm	Spanner Width Upper Body		Lower Body SW Lower Body mm	Outer Ø D mm	max. Height H mm	Part Number
	Inner Sheath Ø min-max mm	Ø min-max mm			Cap SW Cap mm	SW Upper Body mm				
NPT 1/4"	2,0 - 4,0	3,0 - 5,5	0,10 - 0,40	15,0	17	17	17	18,9	62,5	KBA0SN
	3,0 - 8,0	6,0 - 12,0	0,70 - 1,20	15,0	26	26	22	29,0	50,0	KBA0SLN
NPT 3/8"	3,0 - 8,5	6,0 - 12,0	0,70 - 1,20	16,0	26	26	22	29,0	49,5	KBA01SN
	6,0 - 12,0	8,5 - 16,0	0,70 - 1,25	16,0	29	29	25	31,5	52,0	KBA01N
NPT 1/2"	3,0 - 8,5	6,0 - 12,0	0,70 - 1,20	21,0	26	26	24	29,0	49,5	KBA1SN
	6,0 - 12,0	8,5 - 16,0	0,70 - 1,25	21,0	29	29	25	31,5	51,0	KBA1N
	8,5 - 14,5	12,0 - 20,0	0,90 - 1,30	21,0	32	30	28	35,0	54,0	KBA1LN
NPT 3/4"	3,0 - 8,5	6,0 - 12,0	0,70 - 1,20	21,0	26	26	29	31,5	50,0	KBA2XSN
	6,0 - 12,0	8,5 - 16,0	0,70 - 1,25	21,0	29	29	29	31,5	52,5	KBA2SN
	8,5 - 16,0	12,0 - 21,0	0,70 - 1,20	21,0	34	34	32	37,0	56,5	KBA2N
	12,0 - 20,0	16,0 - 26,0	1,30 - 1,70	21,0	40	40	36	44,0	62,5	KBA2LN
NPT 1"	6,0 - 12,0	8,5 - 16,0	0,70 - 1,25	26,0	29	29	36	39,8	52,5	KBA3XSN
	12,0 - 20,0	16,0 - 26,0	1,30 - 1,70	26,0	40	40	40	44,0	64,0	KBA3SN
	15,0 - 26,0	20,0 - 33,0	1,20 - 1,80	26,0	52	52	48	57,0	80,5	KBA3N
NPT 1 1/4"	12,0 - 20,0	16,0 - 26,0	1,30 - 1,70	28,0	40	40	45	50,0	64,0	KBA4XSN
	15,0 - 26,0	20,0 - 33,0	1,20 - 1,80	28,0	52	52	48	57,0	81,0	KBA4SN
	20,0 - 32,0	29,0 - 41,0	1,60 - 2,20	28,0	60	60	55	66,0	92,0	KBA4N
NPT 1 1/2"	15,0 - 26,0	20,0 - 33,0	1,20 - 1,80	28,0	52	52	54	60,0	81,0	KBA5XSN
	20,0 - 32,0	29,0 - 41,0	1,60 - 2,20	28,0	60	60	55	66,0	92,0	KBA5XMN
	22,0 - 35,0	33,0 - 48,0	2,00 - 2,80	28,0	75	70	60	83,0	100,0	KBA5SN
	27,0 - 41,0	36,0 - 52,0	1,80 - 2,80	28,0	74	70	70	81,8	104,5	KBA5N
NPT 2"	22,0 - 35,0	33,0 - 48,0	2,00 - 2,80	28,0	75	70	68	83,0	100,0	KBA6XSN
	27,0 - 41,0	36,0 - 52,0	1,80 - 2,80	28,0	74	70	70	81,8	104,5	KBA6XMN
	35,0 - 45,0	43,0 - 57,0	1,80 - 2,80	28,0	80	80	75	89,5	109,5	KBA6SN
	40,0 - 52,0	47,0 - 60,0	1,80 - 2,80	28,0	85	85	85	94,0	111,5	KBA6N
NPT 2 1/2"	45,0 - 52,0	54,0 - 70,0	1,30 - 2,50	28,0	100	95	90	110,5	128,5	KBA6LN
	35,0 - 45,0	43,0 - 57,0	1,80 - 2,80	41,0	80	80	80	89,5	109,0	KBA7XSN
	40,0 - 52,0	47,0 - 60,0	1,80 - 2,80	41,0	85	85	85	94,0	111,5	KBA7SN
NPT 3"	45,0 - 60,0	54,0 - 70,0	1,00 - 2,30	41,0	100	95	90	110,5	127,5	KBA7N
	40,0 - 52,0	47,0 - 60,0	1,80 - 2,80	43,0	85	85	95	105,0	111,5	KBA8XSN
	45,0 - 60,0	54,0 - 70,0	1,00 - 2,30	43,0	100	95	95	110,5	127,5	KBA8SN
NPT 3 1/2"	60,0 - 72,0	63,0 - 80,0	1,00 - 3,50	43,0	115	115	110	127,0	158,0	KBA8N
	45,0 - 60,0	54,0 - 70,0	1,00 - 2,30	45,0	100	95	110	123,0	127,5	KBA9SN
	60,0 - 72,0	63,0 - 80,0	1,00 - 3,50	45,0	115	115	110	127,0	158,0	KBA9N

Thread Type **NPT** acc. to ANSI ASME B1.20.1 (LT Type)

Outer Thread Size (Male)	Clamping Range		Armour Wire Ø min-max mm	Outer Thread Length TL mm	Spanner Width Upper Body		Lower Body SW Lower Body mm	Outer Ø D mm	max. Height H mm	Part Number
	Inner Sheath Ø min-max mm	Ø min-max mm			Cap SW Cap mm	SW Upper Body mm				
NPT 3 1/2"	70,0 - 82,0	78,0 - 90,0	1,5 - 4,4	45,0	120	120	120	134,0	159,5	KBA9MNL
NPT 4"	80,0 - 92,0	88,0 - 100,0	1,2 - 4,0	46,0	135	135	135	150,0	169,0	KBA10SNLT
	90,0 - 101,0	98,0 - 110,0	2,1 - 5,4	46,0	145	145	145	162,0	180,0	KBA10NLT
NPT 5"	100,0 - 115,0	109,0 - 123,0	2,0 - 5,4	48,0	160	160	160	176,0	202,0	KBA11SNLT