

B Series

LED Explosion Proof Light



Without globe:



B



B2



B3



B4

With globe:

Note: The globe is optional for B, B2, B3 only.
Globe is not available for B4.



Certifications:

- ◆ Marking ATEX
 - ◆ II 3 G Ex ec IIC T6...T3 Gc
 - ◆ II 2 D Ex tb IIIC T85°C...T103°C Db
- ◆ Marking IECEx
 - ◆ Ex ec IIC T6...T3 Gc
 - ◆ Ex tb IIIC T85°C...T100°C Db
- ◆ UL844 Hazardous Locations (North American)
 - ◆ Class I, Division 2, Groups A, B, C, D
 - ◆ Class II, Division 1, Groups E, F, G
 - ◆ Class II, Division 2, Groups F, G
 - ◆ Class III
- ◆ ABS certified
- ◆ CSA certified: C22.2#137:1981
- ◆ IP66

Standard Materials:

- ◆ Housing: Copper-free aluminum
- ◆ Lens: Tempered glass
- ◆ Hardware: Stainless steel
- ◆ Mounting Bracket: Stainless steel

LED Explosion Proof Light - B Series

Key Features:

- ① Dimmable and battery backup function is available.
- ② High-quality SMT LED and Meanwell driver.
- ③ Heavy-duty and high impact resistance.
- ④ Replaceable LED board and drivers.
- ⑤ Integrated junction box for driver.
- ⑥ Marine rating powder coated finish treatment.
- ⑦ Various installation ways for different applications.
- ⑧ Glass lens or polycarbonate lens for making different beam angles.
- ⑨ 5-year warranty.
- ⑩ Low temperature applications to -40°C (-40°F) and high temperature up to 55°C (131°F).
- ⑪ IK08/IK10(with metal guards)

Technical Data:

Model	Wattage	Working Temp.	Operating Voltage	Lumens(lm)	Driver	Efficacy	CRI	CCT	Emergency Time
EX-20W B2YZDA	20W	65°	AC100-277V DC12-48V	2,800	External emergency driver	140lm/W	>70	2200K-7000K	1.5 hours or 3 hours (optional)
EX-40W B2YZDA	40W	55°		5,600					
EX-60W BYZDA	60W	40°	AC100-277V DC12-48V AC200-480V	8,400	Internal emergency driver				
EX-80W BYZDA	80W	40°		11,200					
EX-100W B3YZDA	100W	40°		14,000					
EX-120W B3YZDA	120W	55°		16,800					
EX-150W B3YZDA	150W	50°		21,000					
EX-200W B3YZDA	200W	40°		28,000					
EX-250W B4YZDA	250W	40°		35,000					
EX-300W B4YZDA	300W	40°		42,000					
EX-350W B4YZDA	350W	40°		49,000					
EX-400W B4YZDA	400W	40°	56,000						

Ordering Guide:

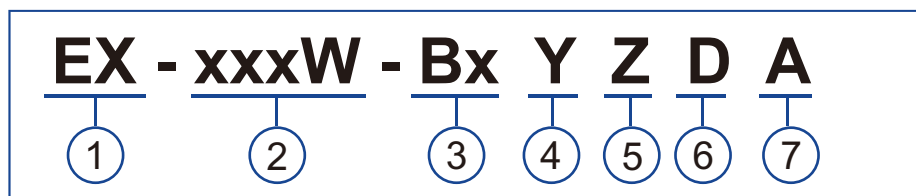

- | | | | |
|--|---|---|---|
| <p>① PRODUCT CATEGORY</p> <ul style="list-style-type: none"> ◆ Explosion proof light | <p>② WATTAGE</p> <ul style="list-style-type: none"> ◆ 20W-400W | <p>③ PRODUCT SERIES</p> <ul style="list-style-type: none"> ◆ B ◆ B2 ◆ B3 ◆ B4 | <p>④ DIMMING OPTION</p> <ul style="list-style-type: none"> ◆ D= dimmable ◆ N= non-dimmable |
| <p>⑤ CCT</p> <ul style="list-style-type: none"> ◆ From 2200K to 7000K ◆ 22=2200K, 30=3000K, ..., 70=7000K | <p>⑥ BEAM ANGLE</p> <ul style="list-style-type: none"> ◆ D40= 40° ◆ D90= 90° ◆ D60= 60° ◆ D120= 120° | <p>⑦ GLASS TYPE</p> <ul style="list-style-type: none"> ◆ A=blank: Flat glass ◆ A=C: Spherical glass & wire guard | |

LED Explosion Proof Light - B Series

Dimensions:

B2 Series

Without globe:

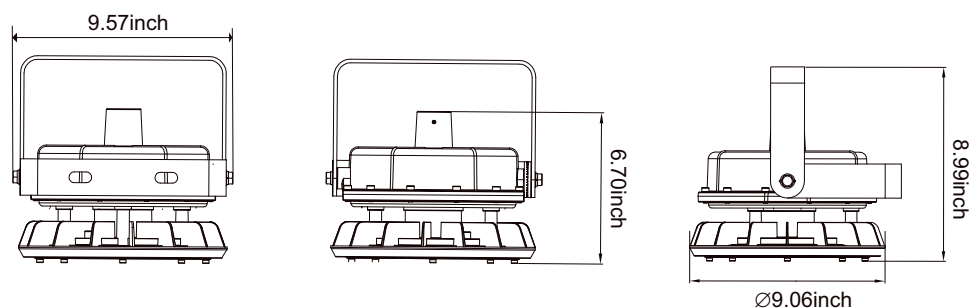

With globe:

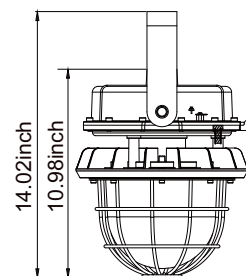

B Series

Without globe:

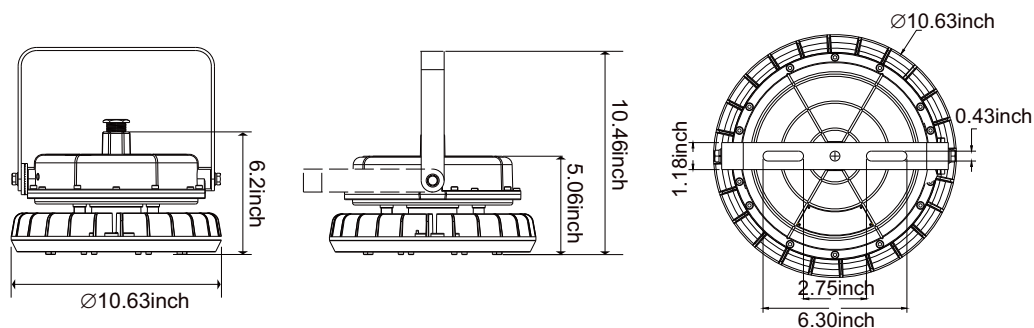

With globe:

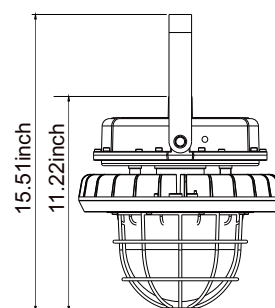

B3 Series

Without globe:

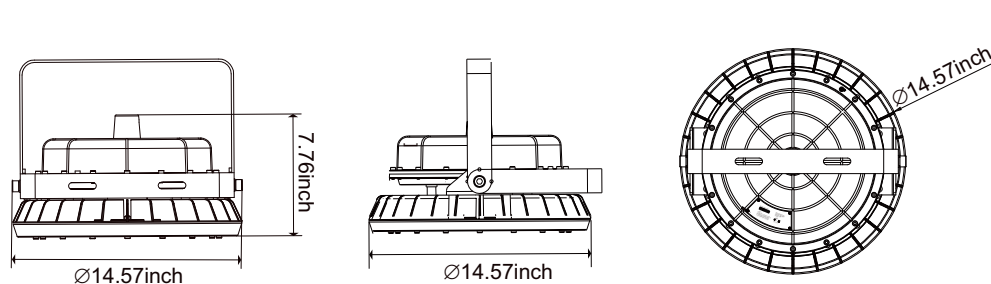

With globe:

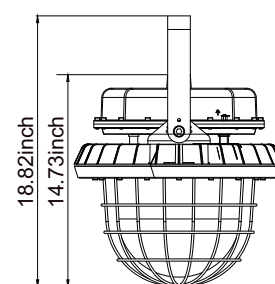

B4 Series

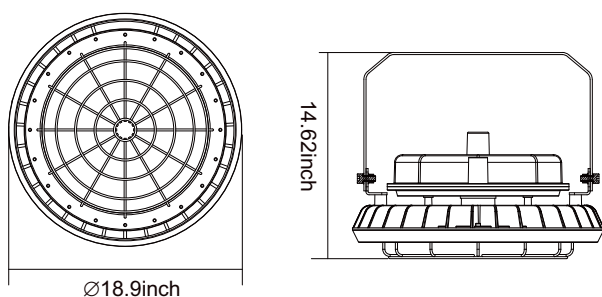

LED Explosion Proof Light - B Series

Photometry:

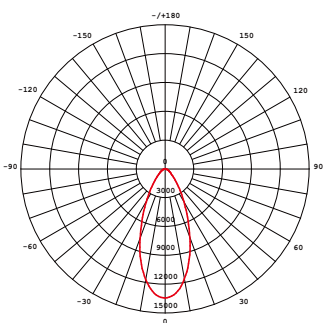

Beam angle: 40°

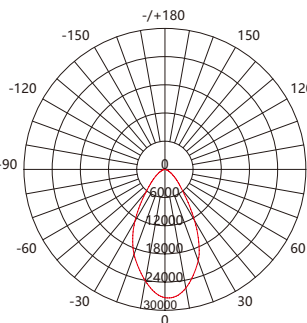

Beam angle: 60°

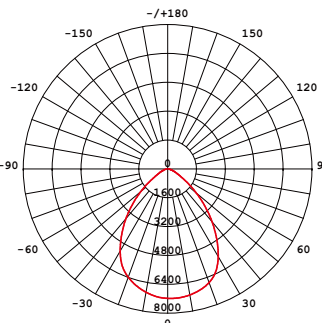

Beam angle: 90°

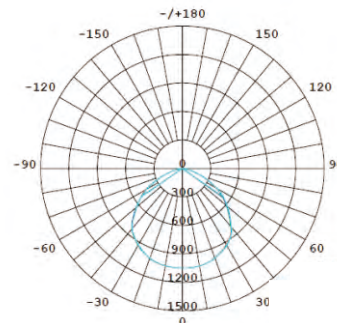

Beam angle: 120°

Packing Information:

Model	Quantity/Carton	Packing Size	Net Weight	Gross Weight
B2	1 PC	14.17x13.94x10.24inch	3.5 kgs/ 7.72 lbs	5 kgs/ 11.02 lbs
B	1 PC	15.19x12.99x8.66inch	4.4 kgs/ 9.70 lbs	5.5 kgs/ 12.13 lbs
B3	1 PC	18.90x18.11x10.43inch	8.2 kgs/ 18.08 lbs	10.5 kgs/ 23.15 lbs
B4	1 PC	20.87x20.87x11.81inch	18.8 kgs/ 41.45 lbs	21.5 kgs/ 47.40 lbs

Mounting Methods:

Ceiling Mounting



⚠ WARNING
 Risk of fire, Electric shock or personal injury
 Before installation, turn off power!

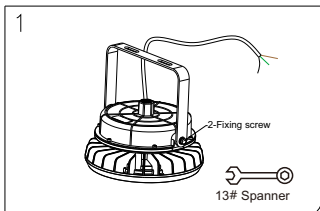

1. Take the fixture and accessory out from carton box, tighten 2x angle holder screw as Fig.1.

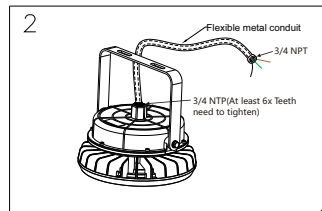

2. Install and tighten flexible metal conduit with the fixture.

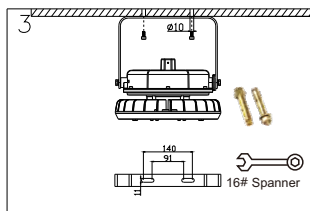

3. Drill 2x hole as shown in Fig.2, the distance can be 91~140mm, fixing $\varnothing 10$ expanded crews and bracket on ceiling.

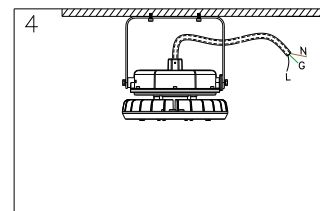

4. Connect black cable to L, Connect White cable to N, Connect green cable to grounding.

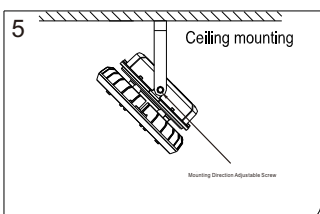

5. Adjust the beam angle from 0-180°.

LED Explosion Proof Light - B Series

Wall Mounting

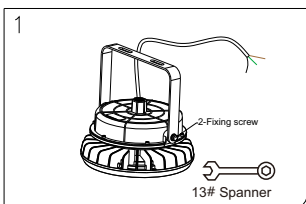

1. Take the fixture and accessory out from carton box, tighten 2x angle holder screw as Fig.1.

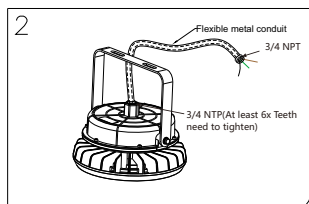

2. Install and tighten flexible metal conduit with the fixture.

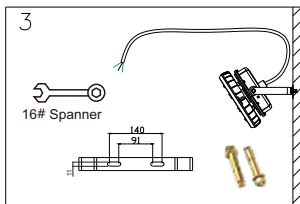

3. Drill 2x hole as Shown in Fig.2, the distance can be 91~140mm, fixing $\varnothing 10$ expansion screws and bracket on ceiling.

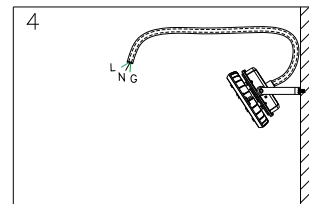

4. Connect black cable to L, Connect White cable to N, Connect green cable to grounding.

Pole Pendant

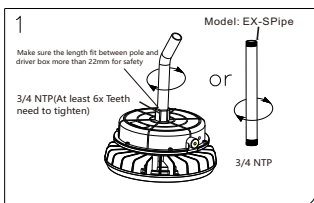

1. Take the fixture and pole accessory out from carton box, tighten pole as shown in Fig.1.

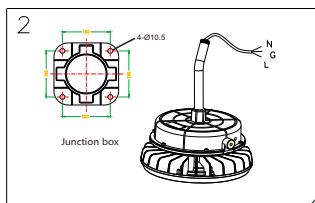

2. Connect black cable to L, Connect White cable to N, Connect green cable to grounding.

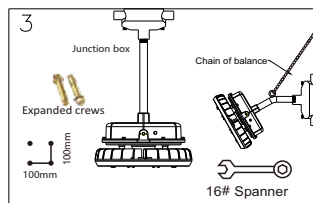

3. Drill 4x $\varnothing 10$ mm holes, as 100mm distance, install the junction box to the wall or ceiling as shown in Fig.3, tighten the pole to the box, and adjust the chain of balance.

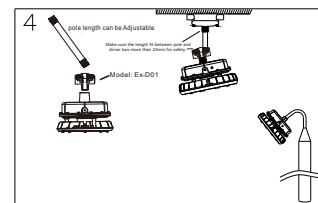

4. Adjustable pole installation. With this adjustable kit, you can Make any light distribution direct as you want. Optional: Install the fixture to the long pole after cable connecting cable.

Hook Pendant

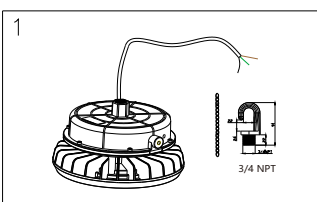

1. Take the fixture and accessory out from carton box, tighten 2x angle holder screw as Fig.1.

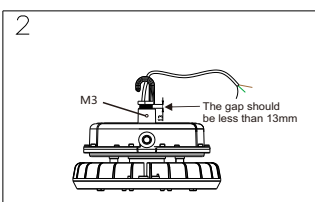

2. Tighten the hook with the fixture, at least 6x teeth need to be tighten, fix the M3 screw to prevent the hook loosening.

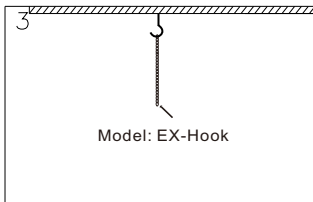

3. Drill 1 expansion screw hole and install it, and hang the chain as shown in Fig.3.

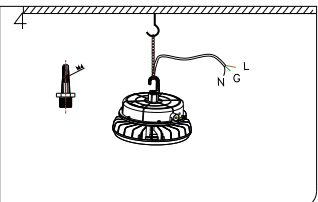

4. Connect black cable to L, Connect White cable to N, Connect green cable to grounding.

Ceiling Mounting by Opening Driver Box

- This installation method is only for Model B. It can not be applied on Model B2, B3, and B4 because they are too heavy.
- Only one electrician is required for this installation.

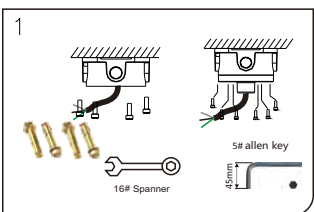

1. Install the junction box to ceiling via 4x expansion bolts, tighten the junction box cover screws by 5# allen key.

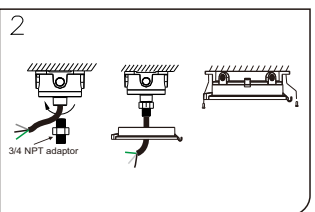

2. Install the 3/4" NPT adaptor through the cable to the hole of adaptor, tighten the driver enclosure cover to adaptor via M4 screw to prevent loosening.

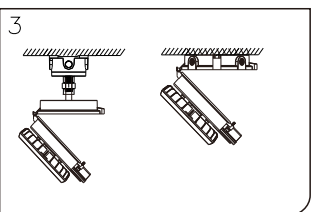

3. Connect black cable to L, Connect White cable to N, Connect green cable to grounding.

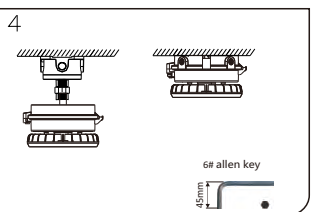

4. Tighten 3x M8 screws for driver enclosure as shown above.

Arm Mounting by Opening Driver Box

- This installation method is only for Model B. It can not be applied on Model B2, B3, and B4 because they are too heavy.
- Only one electrician is required for this installation.

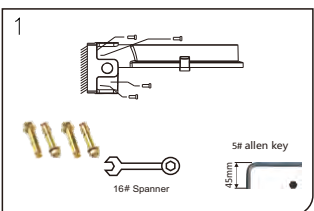

1. Install the 3/4" NPT adaptor through the cable to the hole of adaptor, tighten the driver enclosure cover to adaptor via M4 screw to prevent loosening.

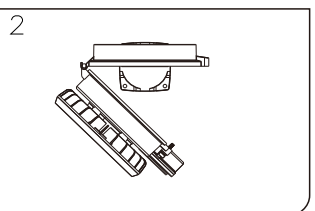

2. Hang the luminaire to the back cover.

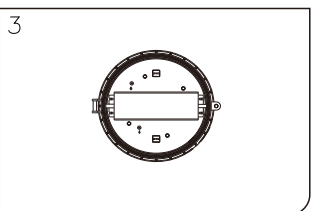

3. Connect black cable to L, Connect White cable to N, Connect green cable to grounding.

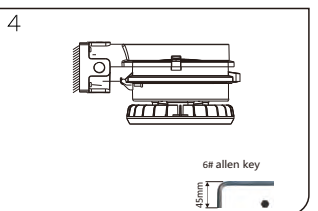

4. Tighten 3x M8 screws for driver enclosure as shown above.

LED Explosion Proof Light - B Series

Arm Mounting by Opening Driver Box

- This installation method is only for Model B. It can not be applied on Model B2, B3, and B4 because they are too heavy.
- Only one electrician is required for this installation.

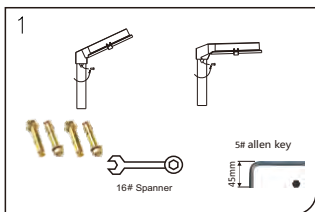

1. Install the 3/4" NPT adapter through the cable to the hole of adaptor tighten the driver enclosure cover to adaptor via M4 screw to prevent loosening.

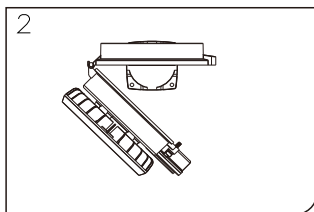

2. Hang the luminaire to the back cover.

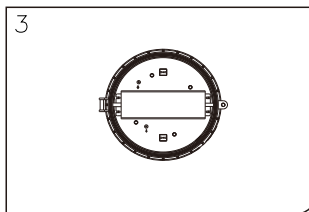

3. Connect black cable to L, Connect White cable to N, Connect green cable to grounding.

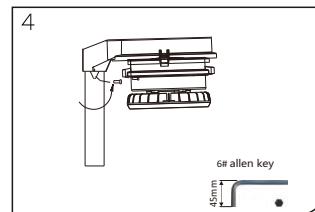

4. Tighten 3x M8 screws for driver enclosure as shown above.

Stanchion Mounting

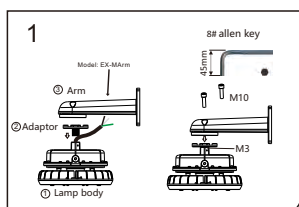

1. Tighten part 2 and assembly 1, and fix the M3 screw, install arm to the adaptor, tighten the M10 via 8# allen key.

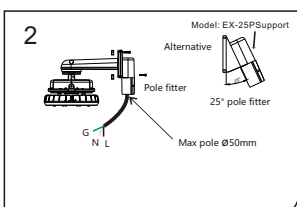

2. Install the pole fitter with arm via 4x M8 screws, the max suitable pole diameter 50mm, the alternative 25 degree pole fitter.

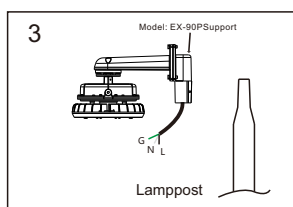

3. Contact the cable to AC wire, black one contact to live wire, white one contact to null wire, green one contact to grounding.

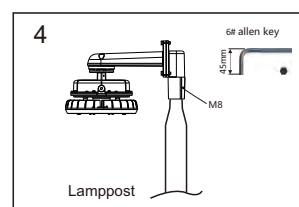

4. Slip the fitter to the lamppost and tighten M8 inner hexagonal screw.

Wall Mounting to Junction Box

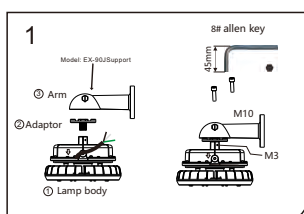

1. Tighten part 2 and assembly 1, and fix the M3 screw, install arm to the adaptor, tighten the M10 via 8# allen key.

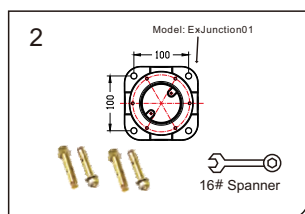

2. Drill 4x Ø10mm holes in the junction box to the wall via M10 expanded screw.

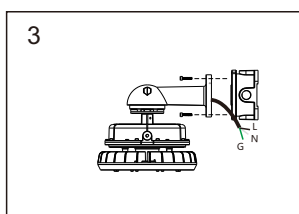

3. Contact the AC wire to power system, black one to Live wire, white one to Null wire, green one to grounding.

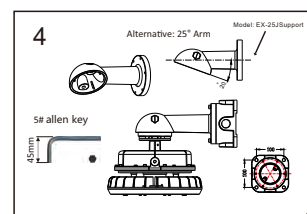

4. Tighten 6 x screws between arm and junction box, turn on the power to test the luminaires is work.

Accessories:



Pole
Ex-Straight Pipe



Pole
Ex-Bended Pipe



Junction Box
EX-HD51-KB1



Stanchion Arm
EX-HD51-KYD 90°



Stanchion Arm
EX-HD51-KYD 25°



Hook
Ex-Hook



Flexible Tube
EX-NG



Pendant
Direction Adapter



Pole Support
Ex-25P Support



Pole Support
Ex-90P Support



Pendant Chain
Ex-Straight Chain



Bracket



Stanchion Arm
Ex-MArm



Cut-off
Lamp Shade



Lamp Shade